







WRFLEX60
PLUG & PLAY

User Manual



	Before you start	03
	Safety	03
	Electrical installation	05
	Technical data	08
	Troubleshooting	09
	Guarantee	10
	What's required for installation	12
	What's in the box	12
	Installation	13
	Connectivity	
	To connect your appliance with another appliance with RF technology please refer to Viceroy Hood Manual.	
	Use	18
	Functions & Settings	20
	Care & Maintenance	26
	Service & Spares	28



| Before you start

These instructions are for your safety. Please read them thoroughly prior to installation and retain them for future reference.

WARNING: All installation work must be carried out by a suitably qualified person, strictly following local building regulations and these instructions.

- To avoid the risks that are always present when you use an electrical appliance it is important that this hob is installed correctly and that you read the safety instructions carefully to avoid misuse and hazards. After unpacking the hob please check that it is not damaged. If in doubt, do not use the appliance but contact Customer Services.
- Check the package and make sure you have all of the parts listed and decide upon the appropriate location for your product. If this product contains glass please take care with fitting or handling to prevent personal injury or damage to the product. The specification plate shown on this appliance displays all the necessary identification information for ordering replacement parts. If you sell the appliance, give it away, or leave it behind when you move house, please ensure that you pass on this manual so that the new owner can become familiar with the appliance and its safety warnings.



People with a heart pacemaker should consult with their doctor before using any induction hob.

| Safety

If the surface of the hob is cracked, switch off the appliance to avoid the possibility of electric shock.

The hob will not be installed directly above a dishwasher, fridge, freezer, washing machine or clothes dryer, as the humidity may damage the hob electronics.

The hob shall be installed such that better heat radiation can be ensured to enhance its reliability.

The wall and induced heating zone above the table surface shall withstand heat.

To avoid any damage, the worktop and adhesive must be resistant to heat.

DANGER OF FIRE: Do not store items on the cooking surfaces.

Unattended cooking on a hob with fat or oil can be dangerous and may result in a fire.

Before obtaining access to terminals, all supply circuits must be disconnected.

The hob and its accessible parts become hot during use.



| Safety (continued)

Use only hob guards designed by the manufacturer of the cooking appliance or indicated by the manufacturer of the appliance in the instructions for use as suitable or hob guards incorporated in the appliance. The use of inappropriate guards can cause accidents.

NEVER try to extinguish a fire with water, but switch off the appliance and then cover flame eg. with a lid or a fire blanket.

This hob can be used by children aged from 8 years and above and persons with reduced physical, sensory or mental capabilities or lack of experience and knowledge if they have been given supervision or instruction concerning use of the appliance in a safe way and understand the hazards involved. Children shall not play with the hood. Cleaning and user maintenance shall not be made by children without supervision. Keep the hob and its supply cord out of the reach of children less than 8 years old.

- CAUTION: The cooking process has to be supervised. A short term cooking process has to be supervised continuously.
- After use, switch off the hob element by its control and do not rely on the pan detector.
- Care should be taken to avoid touching heating elements.
- Metallic objects such as knives, forks, spoons and lids should not be placed on the hob surface since they can get hot.
- Do not use a steam cleaner for care and maintenance.
- The appliance is not intended to be operated by means of an external timer or separate remote control system.
- If the supply cord is damaged, it must be replaced by the manufacturer, its service agent or similarly qualified persons in order to avoid a safety hazard.
- Please dispose of the packing material carefully. There is a fire risk if cleaning is not carried out in accordance with the instructions.
- Do not use the hob if it shows signs of damage or imperfection. Contact customer services for assistance.
- The manufacturer declines all liability for personal or material damage as a result of misuse or incorrect installation of this appliance.
- The appliance incorporates an earth connection for functional purposes only.
- The appliance is for domestic use only as a hob.



| Electrical installation

01 Factory Fitted Power Plug Connection

This hob can be plugged directly into a mains power outlet using the 3 pin (UK) plug supplied.

Power plug option (default, limited to max. input power of 2800W)

As shown in illustration, please plug the power cord into the outlet.

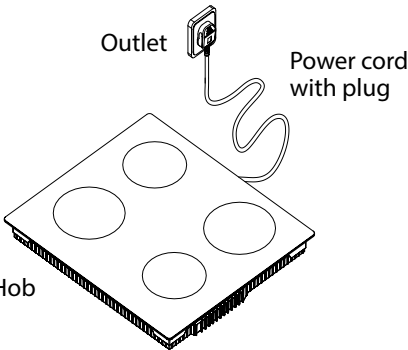
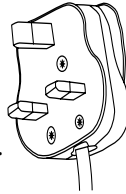

- If the power cable is damaged or to be replaced, the operation must be carried out by the after-sale agent with dedicated tools to avoid any accidents.
- If the appliance is being connected directly to the mains an omnipolar circuit-breaker must be installed with a minimum opening of 3mm between contacts.
- The installer must ensure that the correct electrical connection has been made and that it is compliant with safety regulations.
- The cable must not be bent or compressed.
- The cable must be checked regularly and replaced by authorised technicians only.



Electrical installation

02 Conversion to permanent wiring

THE FOLLOWING SECTION IS FOR PROFESSIONAL QUALIFIED ELECTRICAL INSTALLERS ONLY.

When connected to a mains outlet using the factory fitted plug, the software will limit the hob maximum power to 2800W. Once configured as a permanent installation, the maximum power output is 7200W.

Replacing the cable

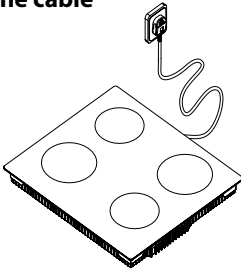

1. Remove the screw and terminal cover.

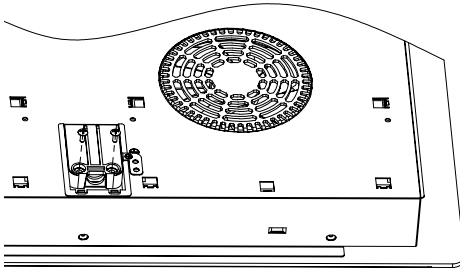

2. Remove the factory fitted cable and replace it with the correct grade for the permanent installation as per the connection diagram below. Power cable can be purchased separately at viceroy.co.uk

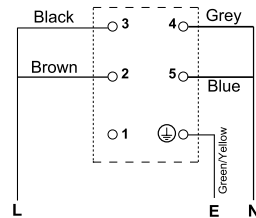
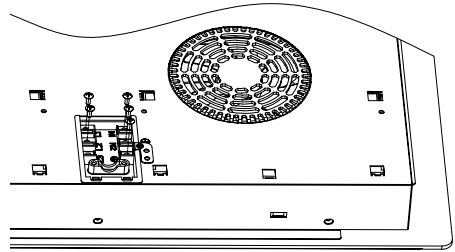

2L:220-240V ac-2 N
5G1.5mm²

WARNING: Do not convert the hob to high power whilst still connected with the factory fitted cable and plug.

**WARNING: Ensure the cable conversion has been completed before proceeding to the software configuration.
FAILURE TO DO THIS WILL DAMAGE THE HOB AND INVALIDATE YOUR WARRANTY!**



Software Configuration

1. Turn on the hob using the ON/OFF key. The hob will show '1-' on each cooking zone.

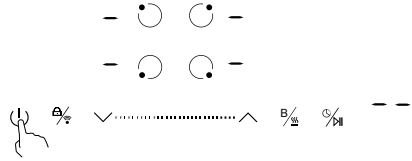

2. Touch the front left zone key and the Timer key together for three seconds. The hob will beep and show '5' in the timer display.

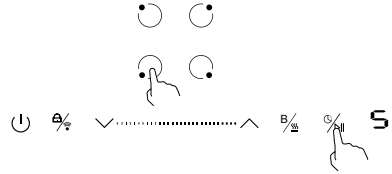

3. Touch the Timer key once and the display will change to '5E'.

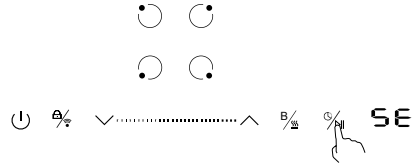

4. Touch the front left zone key and the Timer key again and the two front zones will indicate '2' and '8' (this is the factory setting of 2800W).

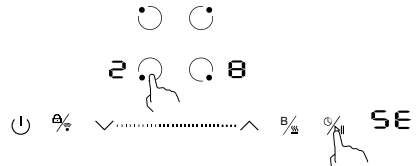

5. Touch the front left zone key to switch the display to '7' and '2'. This indicates high power at 7200W.

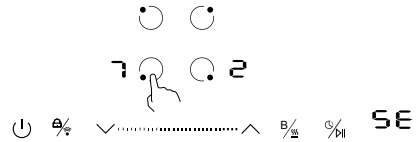

6. Touch the Timer key again to finish configuration.

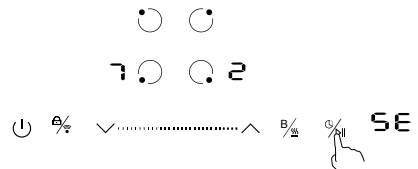

Note: If required, the hob can be converted back to a plugged version by following the cable conversion and software steps above again.



| Technical data

Model identification	WRFLEX60
Cooking zones	4 zones
Supply voltage	220-240V
Installed electric power	7200W (Preset 2800W)
Product size L x W x H (mm)	590 x 520 x 60
Built-in dimensions A x B (mm)	565 x 495

Weight and dimensions are approximate. Because we continually strive to improve our products we may change specifications and designs without prior notice.



| Troubleshooting

IMPORTANT: The connectivity operation above must be completed within two minutes of turning on the power to the cooker hood. If this is not successful, switch off both the hood and the hob, wait for one minute and attempt the connectivity again.

If an abnormality occurs, the induction hob will enter the protective state automatically and display corresponding protective codes:

Error code	Possible cause	Solution
U -	No pan or pan not suitable.	Replace the pan.
ER03	Pan placed over the controls or water on the glass/over the controls.	Clean the control panel or move the pan.
F1 E	The connection between the display board and the left mainboard is fail (the cooking zone which indicator showing 'E')	1. Connection cable not correctly plugged or defective; 2. Replace the mainboard.
F3 E	Coil temperature sensor failure. (the cooking zone which indicator showing 'E')	Replace the coil sensor.
F4 E	Mainboard temperature sensor failure. (the cooking zone which indicator showing 'E')	Replace the mainboard.
E1 E	Temperature sensor of the ceramic glass plate is high.	Please restart after the induction hob cools down.
E2 E	Temperature sensor of the IGBT is high.	Please restart after the induction hob cools down.
E3 E	Abnormal supply voltage (too high)	Please inspect whether power supply is normal; Power on after the power supply is normal.
E4 E	Abnormal supply voltage (too low)	Please inspect whether power supply is normal; Power on after the power supply is normal.
E5 E	Temperature sensor failure (the cooking zone which indicator showing 'E')	Check connection cable is correctly plugged in or assembly defective.

The above is a table of common failures.

Please do not disassemble the unit by yourself to avoid any dangers and damages to the induction hob and please contact the service department.



| Declaration of Conformity

(EU & UK) Declaration of Conformity

Name and address of the manufacturer or his authorised representative:

AAUK Ltd

Good Hope Close

Normanton Industrial Estate

Normanton

West Yorkshire,

WF6 1TR

This declaration of conformity is issued under the sole responsibility of the manufacturer. Object of the declaration:

- **Product: Flex Zone Plug & Play Induction Hob**
- **Model: WRFLEX60**

EU: The object of the declaration described above is in conformity with the relevant Union harmonisation legislation:

- 2014/53/EU as amended Radio Equipment Directive

UK: The object of the declaration described above is in conformity with the relevant legislation:

- Radio Equipment Regulations 2017 as amended

References to the relevant harmonised standards used or references to the other technical specifications in relation to which conformity is declared:

- EN 60335-2-6: 2015 + A1: 2020 + A11: 2020
- EN 60335-1: 2012 + A11: 2014 + A13: 2017 + A1: 2019 + A14: 2019 + A2: 2019
- EN 62233: 2008
- BS EN 60335-2-6: 2015 + A11: 2020
- BS EN 60335-1: 2012 + A2: 2019
- BS EN 62233: 2008
- EN 60350-2:2018
- EN 62479:2010
- EN 61000-3-3:2013+A1:2019
- EN IEC 55014-1:2021
- EN IEC 61000-3-2:2019+A1:2021
- EN 55014-2:2021
- EN 301 489-1 V2.2.3
- EN 301 489-17 V3.2.4
- EN 300 220-2 V3.2.1



| Recycling & disposal

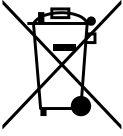

DISPOSAL: Do not dispose this product as unsorted municipal waste. Collection of such waste separately for special treatment is necessary.

This appliance is labelled in compliance with European directive 2011/65/EU for Waste Electrical and Electronic Equipment (WEEE). By ensuring that this appliance is disposed of correctly, you will help prevent any possible damage to the environment and to human health, which might otherwise be caused if it were disposed of in the wrong way.

The symbol on the product indicates that it may not be treated as normal household waste. It should be taken to a collection point for the recycling of electrical and electronic goods.

This appliance requires specialist waste disposal. For further information regarding the treatment, recover and recycling of this product please contact your local council, your household waste disposal service, or the shop where you purchased it.

For more detailed information about treatment, recovery and recycling of this product, please contact your local city office, your household waste disposal service or the shop where you purchased the product.



| What's required for installation

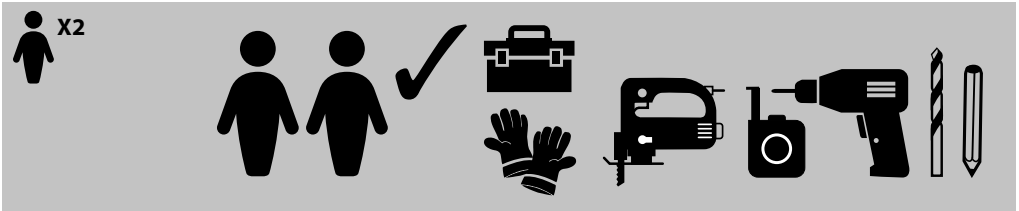

| What's in the box



[01] x 1



[02] x 1



| Cut out work surface

01

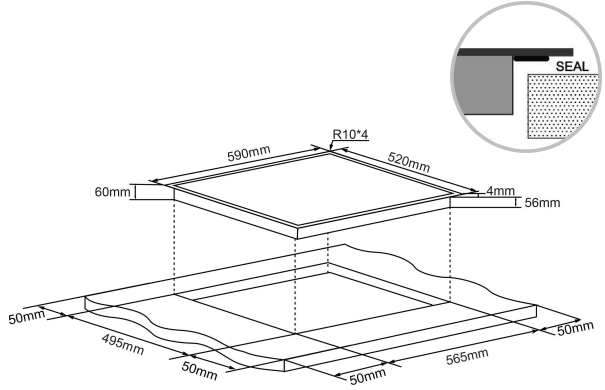

Cut out the work surface according to the sizes shown in the drawing.

For the purpose of installation and use, a minimum of 50mm space shall be preserved around the hole.

Be sure the thickness of the work surface is at least 20mm.

Please select heat-resistant work surface material to avoid larger deformation caused by the heat radiation from the hotplate as shown above.

Make sure the Induction cooker hob is well ventilated and the air inlet and outlet are not blocked.

Note: Where a cooker hood is NOT installed the safety distance between the hotplate and the cupboard above the hotplate should be at least 760mm.

If a cooker hood is installed please refer to the cooker hood user manual for required safety distance.

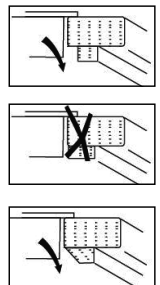
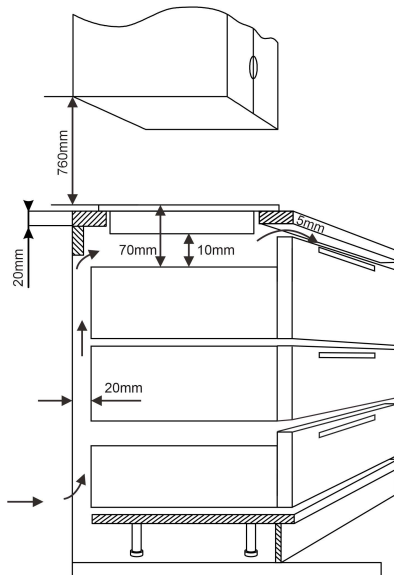
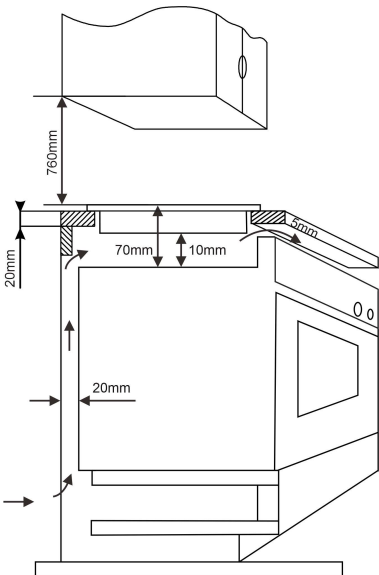



| Before you install the hob

02

Before locating the fixing brackets the hob should be placed on a stable, smooth surface (use the packaging). Do not apply force onto the controls protruding from the hob.

Make sure that . . .

- The work surface is square and level, and no structural members interfere with space requirements.
- The work surface is made of a heat-resistant material.
- If the hob is installed above an oven, the oven has a built-in cooling fan.
- If the appliance is installed above a drawer the hob ventilation can warm up the items stored in the drawer during the cooking process.
- There is adequate flow of fresh air from outside the cabinetry to the base of the hob.
- The power supply cable is not accessible through cupboard doors or drawers.
- The installation will comply with all clearance requirements and applicable standards and regulations.
- A suitable isolating switch providing full disconnection from the mains power supply is incorporated in the permanent wiring, mounted and positioned to comply with the local wiring rules and regulations.
- The isolating switch must be of an approved type and provide a 3 mm air gap contact separation in all poles (or in all active [phase] conductors if the local wiring rules allow for this variation of the requirements).
- The isolating switch will be easily accessible to the customer with the hob installed.
- You consult local building authorities and by-laws if in doubt regarding installation.
- You use heat-resistant and easy-to-clean finishes (such as ceramic tiles) for the wall surface surrounding the hob.



| Seal the work surface & hob

03

Cut out worktop to supplied dimensions shown in **DIAGRAM 01** with suitable equipment. Seal the cut edge of the worktop using silicone or PTFE prior to fitting the hob.

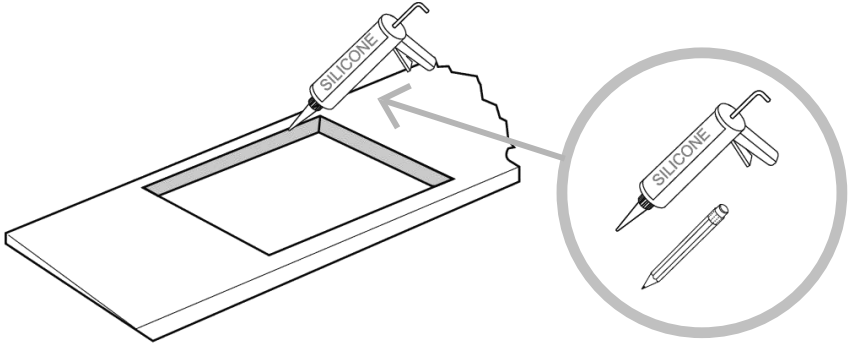

IMPORTANT: Ensure that the product is fully cured as per the manufacturers instructions before you commence installation of the hob. The hob MUST NOT be sealed into the worktop.



04

Stretch out and stick the supplied seal along the underside edge of the hob, ensuring the ends overlap.



[02] x 1

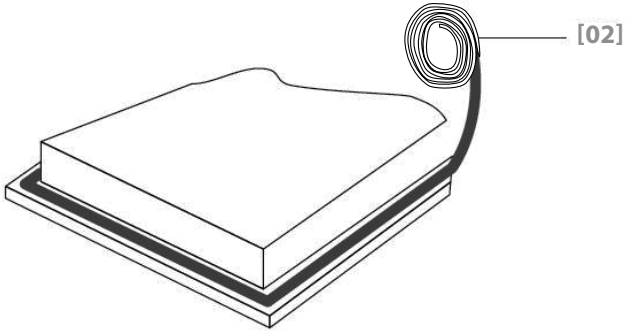



05

WARNING: Do not use adhesive to fix the hob into the worktop.

Once the seal is fitted, position the hob into the cut-out in the worktop. Apply gentle downwards pressure onto the hob to push it into the worktop ensuring a good seal around the outer edge as shown.

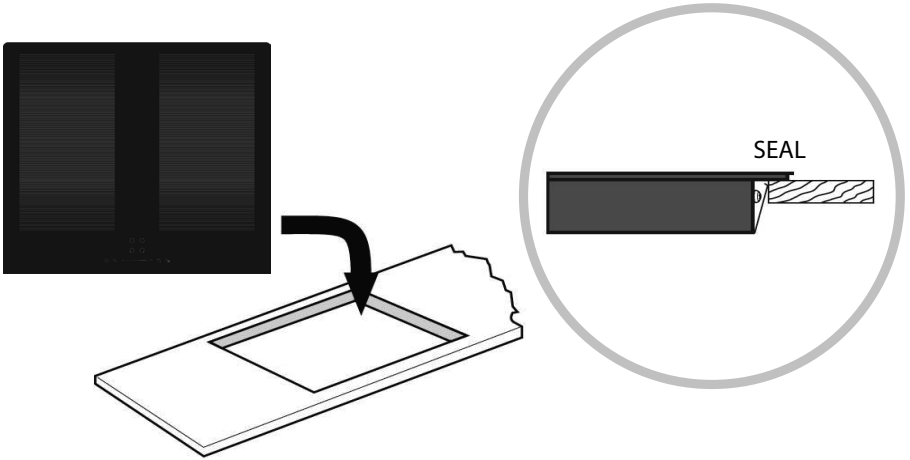

| Induction Cooking

Before using your Induction Hob

- Read this guide, taking special note of the Safety section.
- Remove any protective film that may still be on your Induction hob.

Induction cooking is a safe, advanced, efficient, and economical cooking technology. It works by electromagnetic vibrations generating heat directly in the pan, rather than indirectly through heating the glass surface. The glass becomes hot only because the pan eventually warms it up.

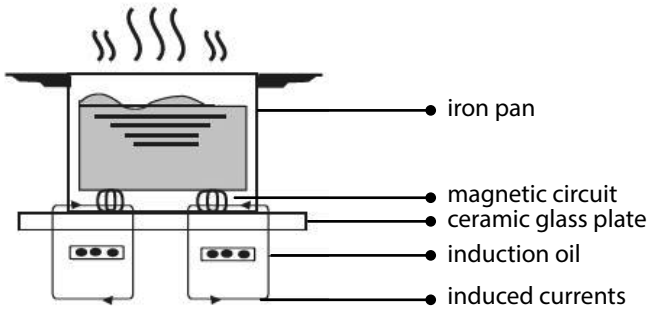

Using the Touch Controls

- The controls respond to touch, so you don't need to apply any pressure.
- Use the ball of your finger, not its tip.

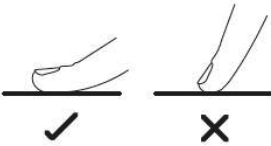

- You will hear a beep each time a touch is registered.
- Make sure the controls are always clean, dry, and that there is no object (e.g. a utensil or a cloth) covering them. Even a thin film of water may make the controls difficult to operate.

| Choosing the right cookware



Only use cookware with a base suitable for induction cooking. Look for the induction symbol on the packaging or on the bottom of the pan.

- You can check whether your cookware is suitable by carrying out a magnet test. Move a magnet towards the base of the pan. If it is attracted, the pan is suitable for induction.

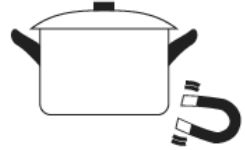

If you do not have a magnet:

1. Put some water in the pan you want to check.
2. If  does not flash in the display and the water is heating, the pan is suitable.

Cookware made from the following materials is not suitable: pure stainless steel, aluminium or copper without a magnetic base, glass, wood, porcelain, ceramic and earthenware.

Do not use cookware with jagged edges or a curved base.

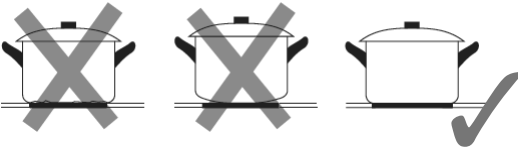

Make sure that the base of your pan is smooth, sits flat against the glass, and is the same size as the cooking zone. Use pans whose diameter is as large as the graphic of the zone selected. Using a pot a slightly wider energy will be used at its maximum efficiency. If you use smaller pot efficiency could be less than expected. Pot less than 140 mm could be undetected by the hob. Always centre your pan on the cooking zone.

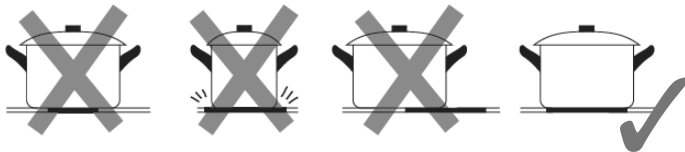

Always lift pans off the Induction hob – do not slide, or they may scratch the glass.

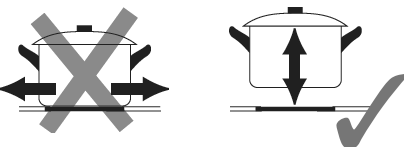

 | Before you start

WARNING: Read the instructions before using the appliance.



People with a heart pacemaker should consult with their doctor before using any induction hob.



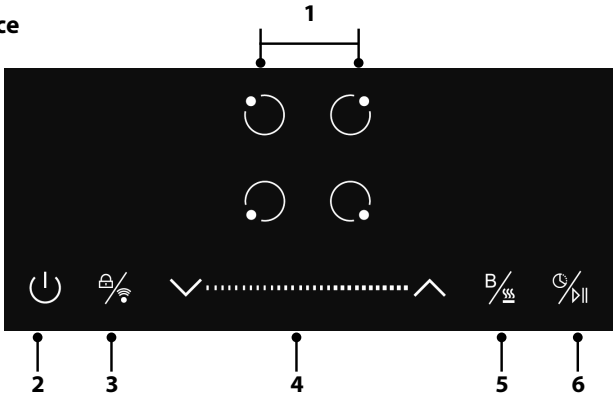

Switch on the appliance at the plug socket or double pole isolation switch. The appliance is ready for use.

| Functions & Settings

01 User interface



1. Zone Select Key
2. On/Off Key
3. Child Lock/Connectivity Key
4. Power/Timer Slider Regulating Key
5. Boost Control/Keep Warm Key
6. Timer/Pause Key

Heating Zone	Max. Power (220-240V~50/60Hz)
	2000/2800W (Booster)
	1500/2000W (Booster)
	1500/2000W (Booster)
	2000/2800W (Booster)
Left Flexible Zone	3000/3600W (Booster)
Right Flexible Zone	3000/3600W (Booster)
Limit Rating Power	2800W



02 General Use



Boost Control/Keep Warm Functions

Activate Boost Control

- Select the heating zone you wish to use by touching the relevant Zone Select Key.
- Touching the Boost Control/Keep Warm Key, the zone indicator will show 'P' and the power reaches Max.

Cancel Boost Control

- Touching the relevant Zone Select Key that you wish to cancel.
- Touching the Slider Regulating Key

to choose the new power level.
- The function can work in any cooking zone.
- The cooking zone returns to level 9 after 5 minutes.

Activate Keep Warm Function

- Touch the Zone Select Key button of the zone that you wish to keep warm, an indicator next to the key will flash.
- Touch the Boost Control/Keep Warm Key and hold for 3 seconds, the cooking zone indicator will display 

Cancel Keep Warm Function

- Select the cooking zone you wish to operate, and then touch the Boost Control/Keep Warm Key and hold for 3 seconds. The cooking zone will be **OFF**.



Child Lock Function

- You can lock the controls to prevent unintended use (for example children accidentally turning the cooking zones on).
- When the controls are locked, all the controls except the **OFF** control are disabled.

To lock the controls

- Touch the Key Lock Control for 3 seconds. The Timer indicator will show 'Lo'.

To unlock the controls

1. Make sure the Induction hob is turned on.
2. Touch and hold the Key Lock Control for a while.
3. You can now start using your Induction hob.



When the hob is in the lock mode, all the controls are disabled except OFF, you can always turn the hob off with the OFF control in an emergency, but you shall unlock the hob first in the next operation.



Pause Function

The hob has a handy restart function to pause and restart the cooking process if you're interrupted.

- When the hob is on and working, press the Pause Key and hold for 3 seconds, all burner will stop working, and all LED indicator will show the symbol '='.
- Press the Pause Key and hold for 3 seconds again, all functions will restart at the previous setting.

02 General Use



Timer/Pause Functions

You can use the timer in two different ways:

- You can use it as a Minute Minder. In this case, the timer will not turn any cooking zone off when the set time has expired.
- You can set it to turn one cooking zone off after the set time has expired.
- You can set the timer for up to 99 minutes.

Using the Timer as a Minute Minder if you are not selecting any cooking zone:

1. Make sure at least one cooking zone is turned on.

Note: you can use the Minute Minder even if you're not selecting any cooking zone.

2. Touch the Timer Key .
The minder indicator will start flashing and '10' will show in the timer display.
3. Set the time by touching the \vee or \wedge control of the timer

Hint: Touch the \vee or \wedge control of the timer once to decrease or increase by 1 minute.

Touch and hold the \vee or \wedge control of the timer to decrease or increase by 10 minutes.

Touching the \vee until the timer indicator display shows '00' to cancel the timer.

4. When the time is set, it will begin to count down immediately. The display will show the remaining time .

5. Buzzer will beep for 30 seconds and the timer indicator will turn off when the set time has expired.

Setting the timer to turn one or more cooking zones off if the timer is set on one zone:

1. Select the relevant cooking zone which is working by touching the Zone Select Key.
2. Press the Timer Key .
The minder indicator will start flashing '10' and you can set the timer at this point.
3. Using the \vee or \wedge control you can set the timer from 1 to 99 minutes.

Hint: Touch the \vee or \wedge control of the timer once to decrease or increase by 1 minute.

Touch and hold the \vee or \wedge control of the timer to decrease or increase by 10 minutes.

Touching the \vee until the timer indicator display shows '00' to cancel the timer.

4. When the time is set, it will begin to count down immediately. The display will show the remaining time and the timer indicator flashes for 5 seconds.

NOTE: The red dot next to power level indicator will illuminate indicating that zone is selected.



5. When cooking timer expires, the corresponding cooking zone will be switched off automatically.
6. Other cooking zones will keep operating if they were turned on previously.
7. When using 'the timer as an alarm' and 'the timer to switch off the zones' together, the display will show the remaining time of alarm as first priority. Press cooking zone to show the remaining time of switch-off timer.



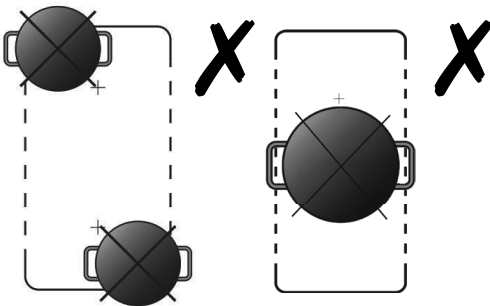
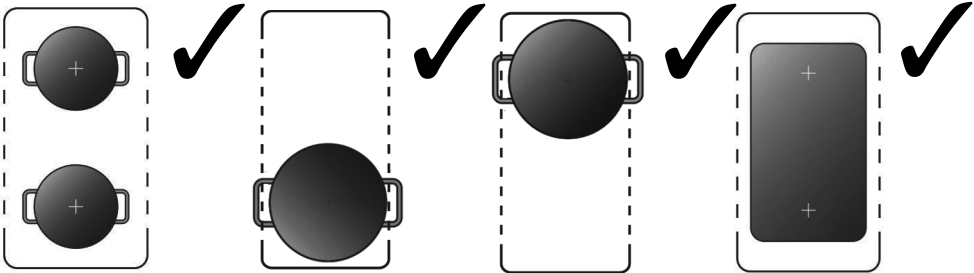

03 Flexible Area

- This area can be used as a single zone , according to the cooking needs anytime.
- Flexible area is made of two independent inductors that can be controlled separately.
- When working as a single zone, and cookware is moved from one zone to the other one within the flexible area keeping the same power level of the zone where the cookware originally was placed, and the part that is not covered by cookware is automatically switched off.

IMPORTANT: Make sure cookware is placed centred on the single cooking zone. To use the whole flexible zone use a rectangular or oval cooking pan. Examples of good pan placement and bad pan placement are shown below.



03 Flexible Area
To activate the flexible area as a single big zone

1. Press the Zone Select Key  and  at the same time for the left group
or
press the Zone Select Key  and  at the same time for the right group.
2. The flexible zone indicator  above the power lever indicator will be lit up.

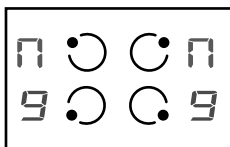



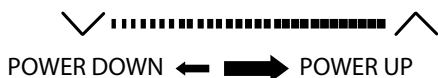

3. According to the heating zone where the pan is placed, adjust heat setting by touching the front Slider Regulating Key.



4. If the pan is moved from the front to the rear part (or vice versa), the flexible area detects automatically the new position, keeping the same power.

To deactivate the flexible area

1. Press the Zone Select Key  and  at the same time hold 3 seconds for the left group
or
press the Zone Select Key  and  at the same time hold 3 seconds for the right group.

Over-Temperature Protection

An internal temperature sensor will monitor the temperature inside the induction hob. When an excessive temperature is detected, the induction hob will stop operation automatically.

Detection of Small Articles

When an unsuitable size or non-magnetic pan (e.g. aluminium), or some other small item (e.g. knife, fork, key) has been left on the hob, the hob will automatically go onto standby in 1 minute. The fan will keep cooling down the induction hob for a further 1 minute.

Auto Shutdown Protection

Auto Shutdown is a safety protection function for your induction hob. It will shut down automatically if ever you forget to turn off your cooking. The default working times for various power levels are shown in the below table:

Power Level	Default Working Timer (min)
1-3	360
4-6	180
7-8	120
9	90

When the pan is removed, the induction hob can stop heating immediately and the hob automatically switches off after 2 minutes.

04 | Using your Induction Hob

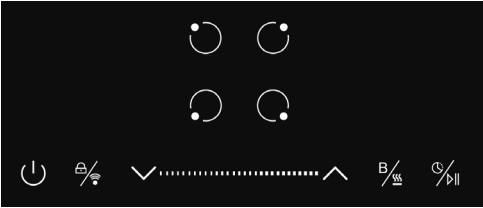

To start cooking

1. Touch the ON/OFF key  for 3 seconds.

After power on, the buzzer beeps once, all displays show 'H', indicating that the induction hob has entered the state of standby mode.

2. Place a suitable pan on the cooking zone that you wish to use.

Make sure the bottom of the pan and the surface of the cooking zone are clean and dry.

3. According to the heating zone where the pan is placed, select a relevant Zone Select Key by pressing  key.

4. Adjust heat setting by touching the Slider Regulating Key.



POWER DOWN ←  POWER UP

- If you don't choose a heat setting within 1 minute, the induction hob will automatically switch off. You will need to start again at Step 1.
- You can modify the heat setting at any time during cooking.

If the display flashes  alternately with the heat setting 

This means that:

- You have not placed a pan on the correct cooking zone,
or
the pan you're using is not suitable for induction cooking,
or,
the pan is too small or not properly centred on the cooking zone.
- No heating takes place unless there is a suitable pan on the cooking zone. The display will automatically turn off after 1 minute if no suitable pan is placed on it.

When you have finished cooking

- Touch the relevant Zone Select Key that you wish to switch off.
- Alter the power output level to zero.
- **Beware of hot surfaces**
'H' will show which cooking zone is hot to touch. It will disappear when the surface has cooled down to a safe temperature. It can also be used as an energy saving function if you want to heat further pans, by using the hotplate that is still hot.



| Looking after your appliance

IMPORTANT: Always switch off the electricity supply before performing any maintenance work.

The appliance should be cleaned after use, allow to cool first!

Type of dirt	Cleaning method	Cleaning materials
Limescale	Apply white vinegar to the surface, then wipe it dry with soft cloth.	Special induction hob cleaner
Burnt-on stains	Clean with damp cloth and dry it with a soft cloth.	Special induction hob cleaner
Light stains	Clean with damp cloth and dry it with a soft cloth.	Cleaning sponge
Melted plastics	Use a scraper suitable for induction glass to remove residue.	Special induction hob cleaner

CAUTION: Avoid rubbing with any abrasive or with the base of the pans, etc. as this will wear the markings on the top of the induction hob over time. Clean the induction hob on a regular basis to prevent the build up of food residue.

Never use:

- Undiluted washing-up liquid
- Detergent intended for dishwashers
- Scouring agents
- Harsh cleaning agents such as oven spray or stain remover
- Abrasive sponges
- High-pressure cleaners or steam jet cleaners

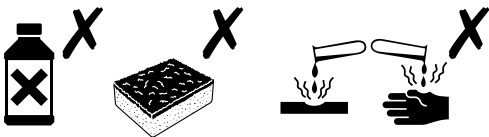



| After sales & service support



For after sales, service enquiries & spares support

Please contact: **0333 247 1128**

Monday to Friday: 9am-5pm

Saturday: 9am-1pm

Email enquiries: wrenservice@apelson.co.uk

Dedicated spares online at: viceroy.co.uk

此页不印刷
This page will
not be printed

70g双胶纸 A5 单色印刷
版本号：20250312 V0.4